



Rosemary

2,055 Square Feet

Community: Taylor Creek

LOW VOLTAGE LEGEND	
LOGO	DESCRIPTION
	COAXIAL CABLE
	DATA
	ISP JUNCTION

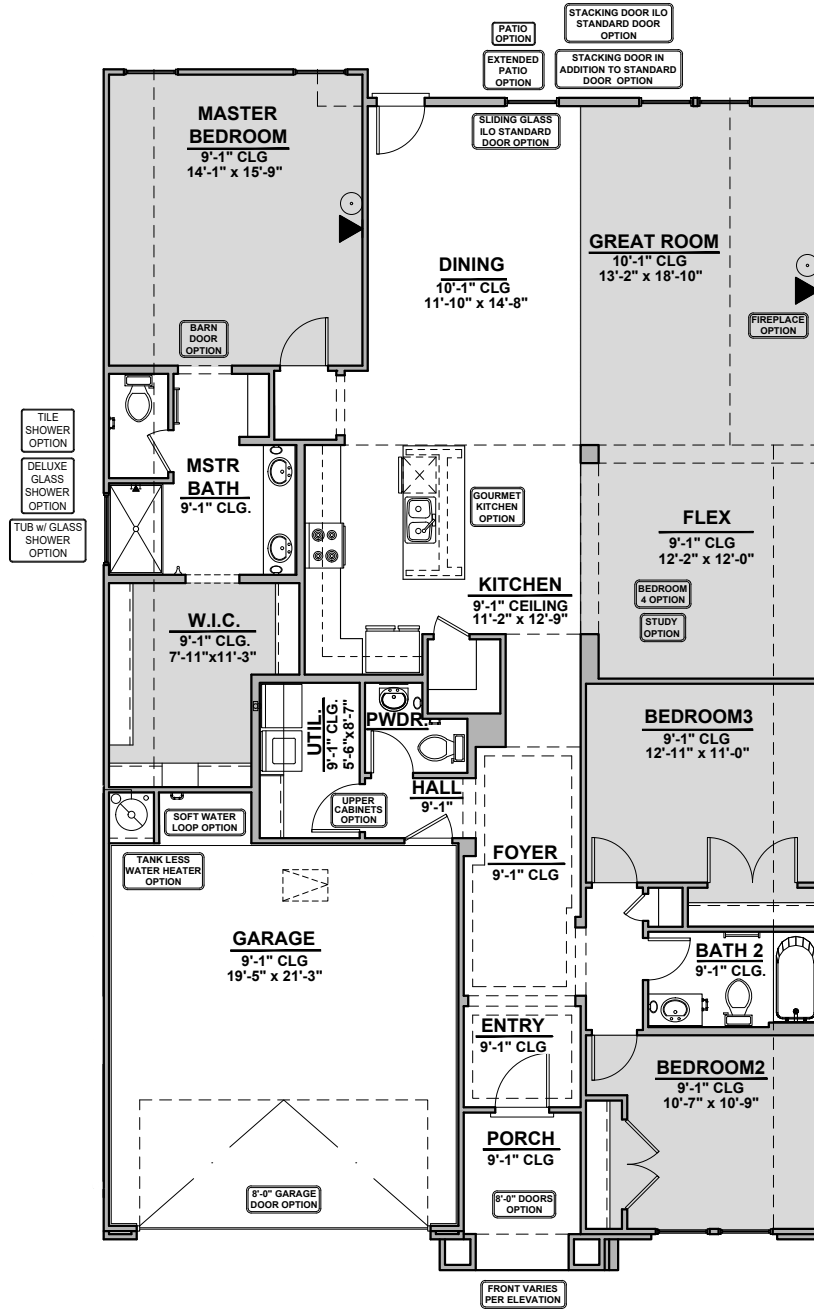

Home is complete and accepted as built. _____

Home construction is in process, buyer accepts all option locations. _____



Rosemary Elevations

2,055 Square Feet
Community: Taylor Creek

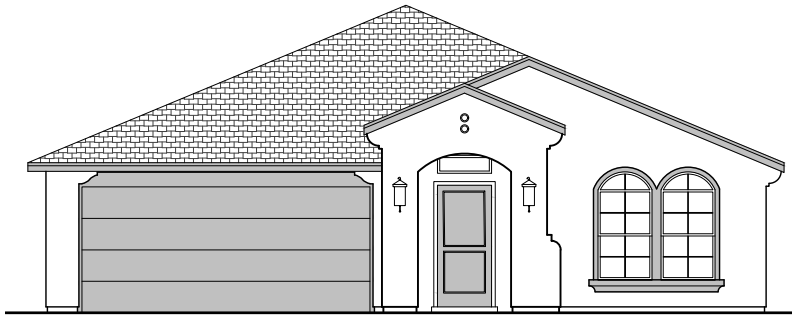

Spanish Colonial (A)



Tuscan (B)



Farmhouse (I)



Rosemary Options

2,055 Square Feet

Community: Taylor Creek

LOW VOLTAGE LEGEND	
LOGO	DESCRIPTION
	COAXIAL CABLE
	DATA
	ISP JUNCTION

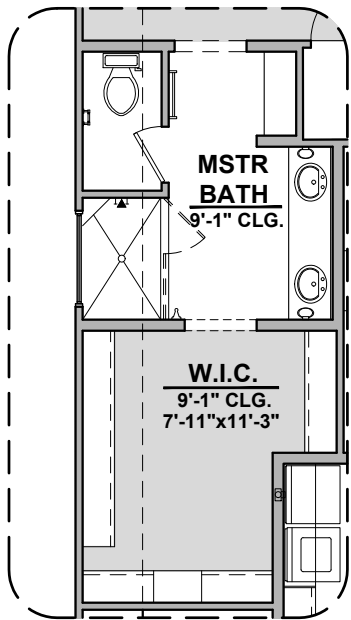

Tile Shower

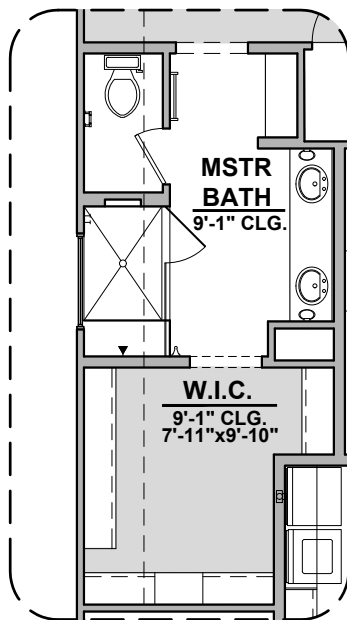

Deluxe Glass Shower

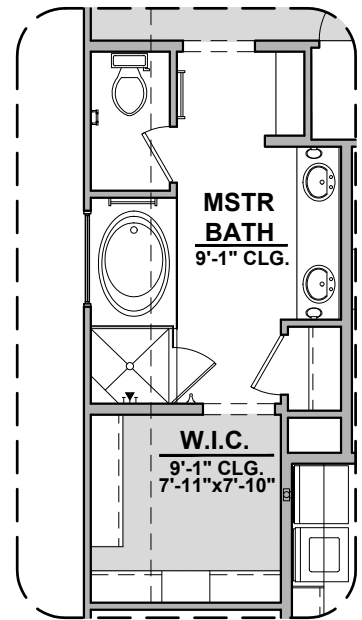

Tub w/ Glass Shower

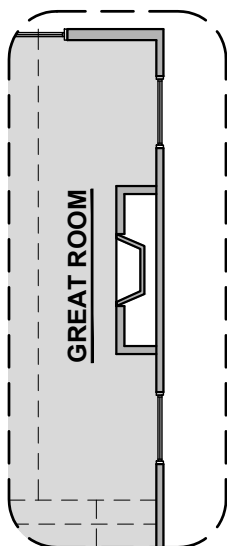

Fireplace

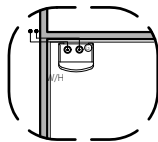

Tankless W/H

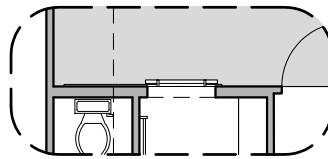

Barn Door

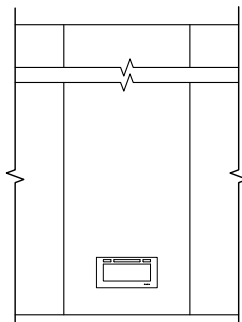

**Contemporary
Fireplace**

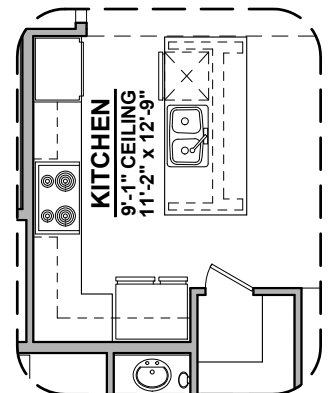

Gourmet Kitchen



Rosemary Options

2,055 Square Feet

Community: Taylor Creek

LOW VOLTAGE LEGEND	
LOGO	DESCRIPTION
	COAXIAL CABLE
	DATA
	ISP JUNCTION

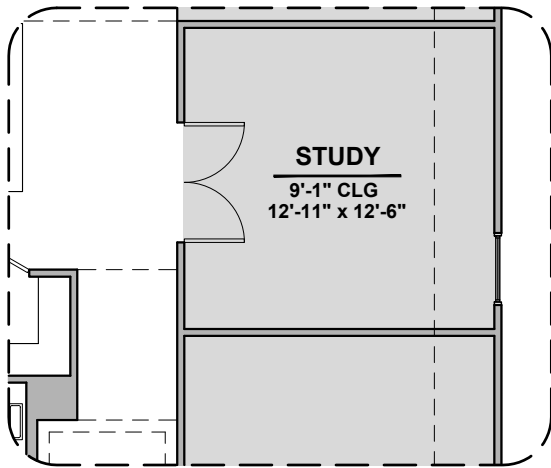

Study

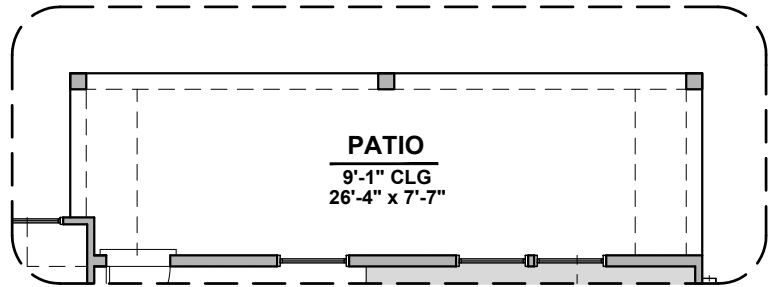

Extended Patio

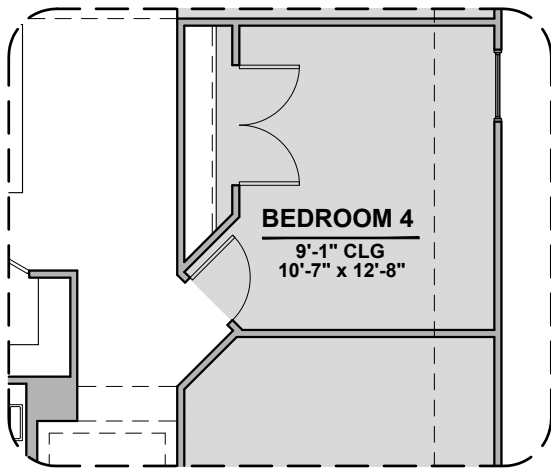

Bedroom 4

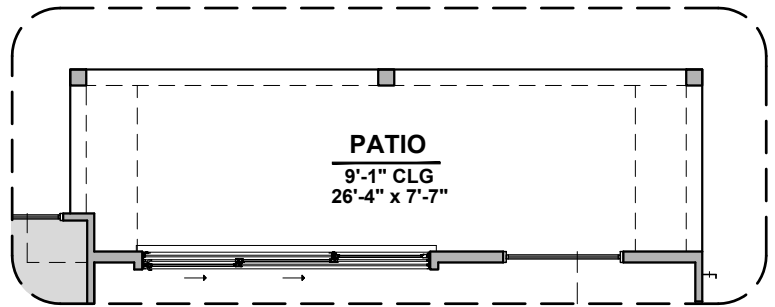

Stacking Door ILO STD. Door

*Note: All vinyl in Great Room with this option

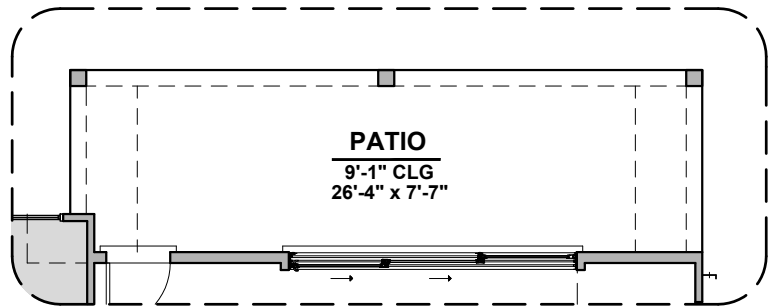

Stacking Door in Add. to STD. Door

*Note: All vinyl in Great Room with this option

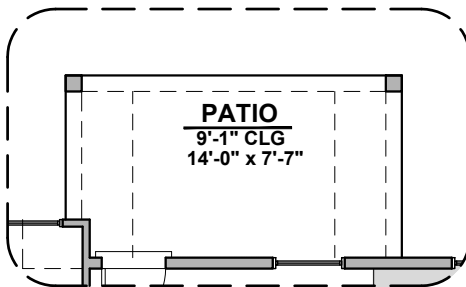

Patio

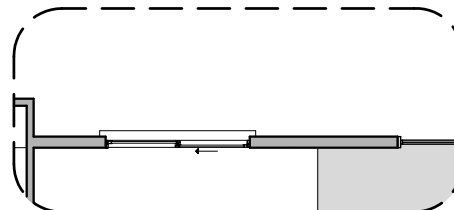

**Sliding Glass Door
ILO STD. Door**