



Duranta

1,675 Square Feet

Community: Taylor Creek

| LOGO | DESCRIPTION |
|------|---------------|
| | COAXIAL CABLE |
| | DATA |
| | ISP JUNCTION |

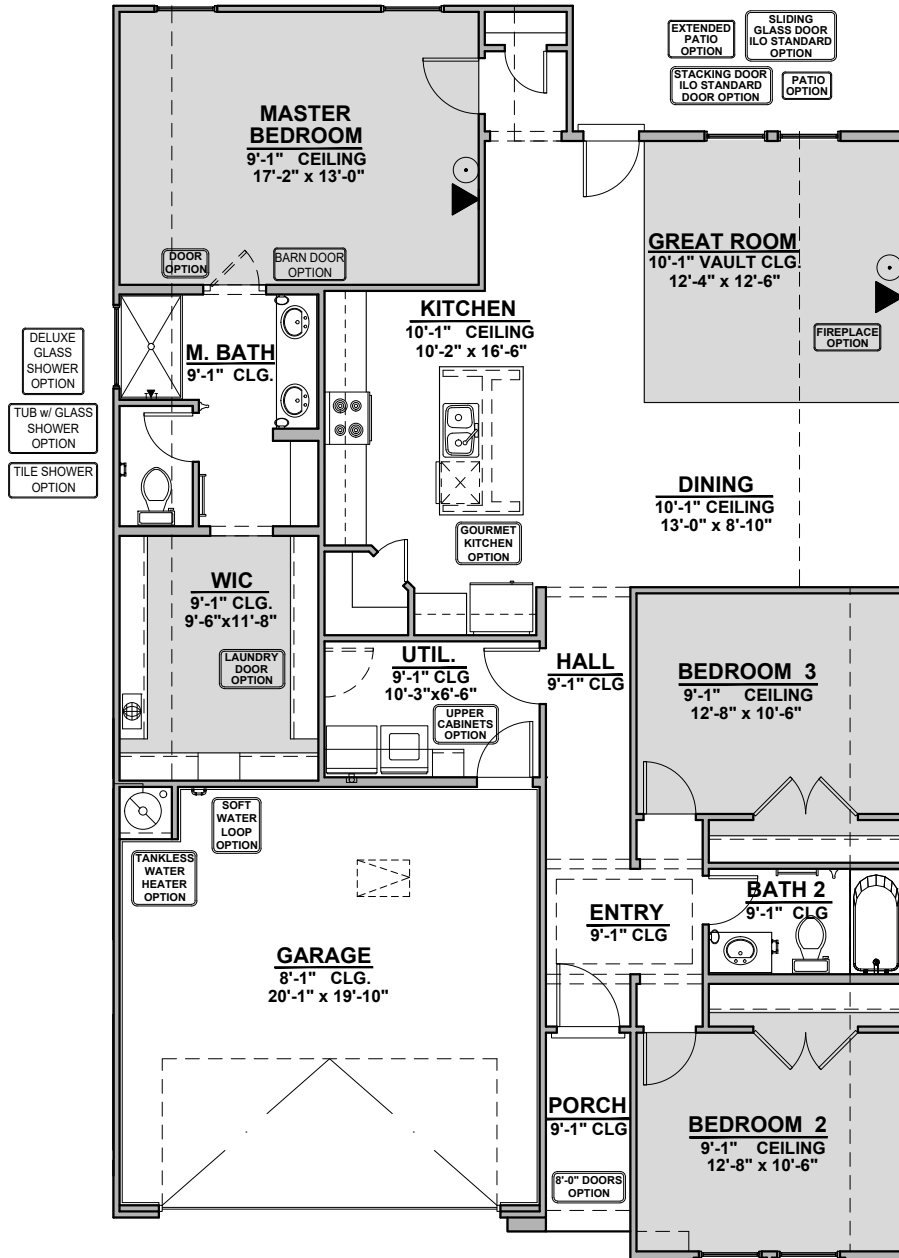

- Home is complete and accepted as built. _____
- Home construction is in process, buyer accepts all option locations. _____



Duranta Elevations

1,675 Square Feet

Community: Taylor Creek

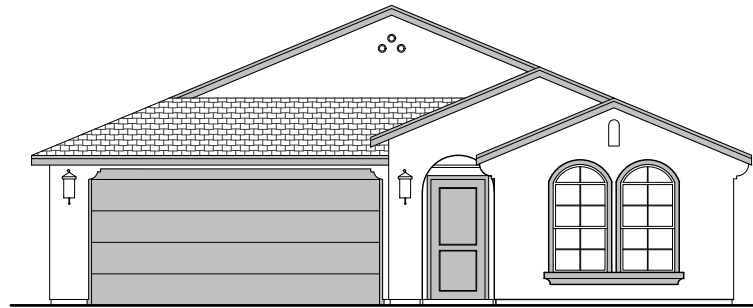

Spanish Colonial (A)



Tuscan (B)



Farmhouse (I)



Duranta Options

1,675 Square Feet
Community: Taylor Creek

| LOW VOLTAGE LEGEND | |
|--------------------|---------------|
| LOGO | DESCRIPTION |
| | COAXIAL CABLE |
| | DATA |
| | ISP JUNCTION |

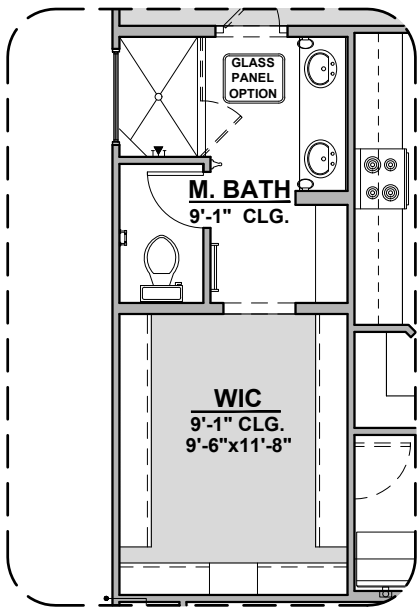

TILE SHOWER OPTION
1/4" = 1'-0"

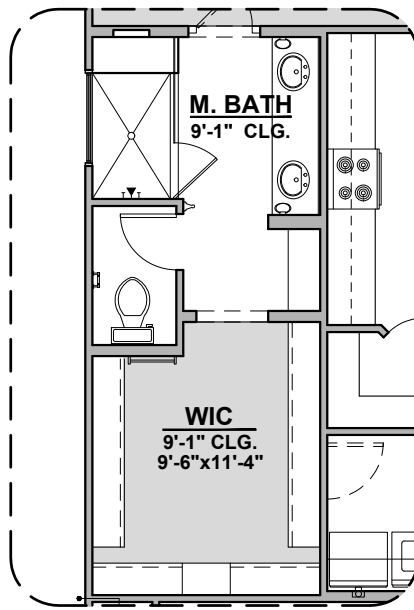

DELUXE GLASS SHOWER OPTION
1/4" = 1'-0"

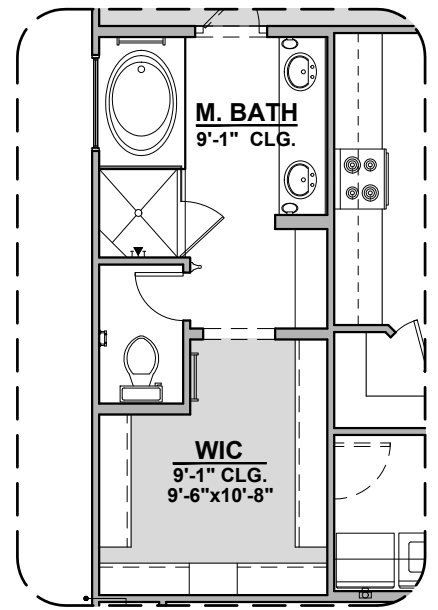

TUB w/ GLASS SHOWER OPTION
1/4" = 1'-0"

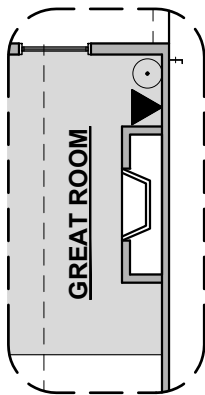

Fireplace

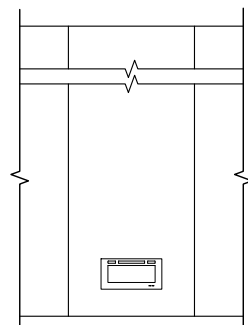

**Contemporary
Fireplace**

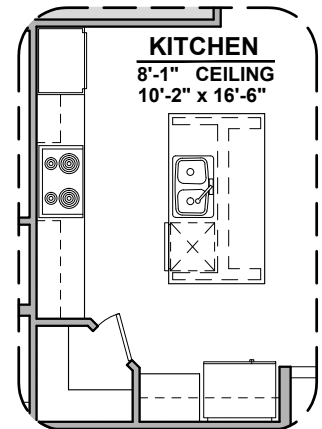

Gourmet Kitchen



Duranta Options

1,675 Square Feet
Community: Taylor Creek

| LOW VOLTAGE LEGEND | |
|--------------------|---------------|
| LOGO | DESCRIPTION |
| | COAXIAL CABLE |
| | DATA |
| | ISP JUNCTION |

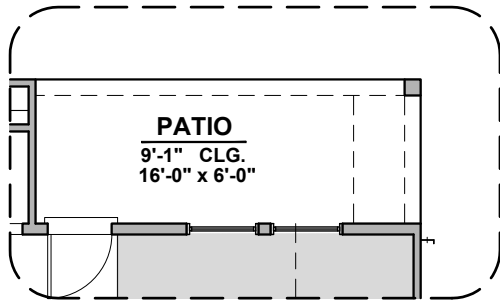

Patio

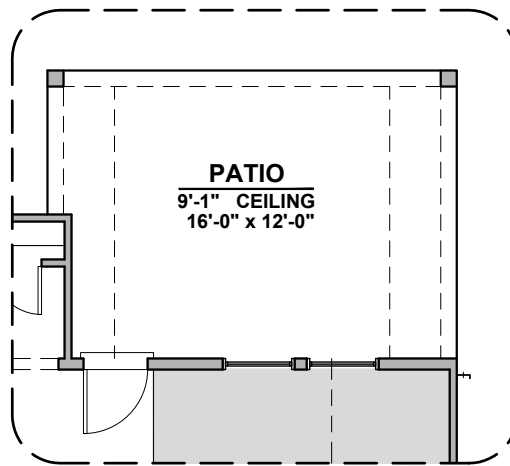

Extended Patio

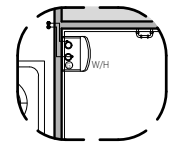

Tankless W/H

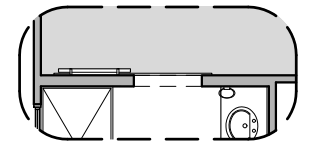

Barn Door

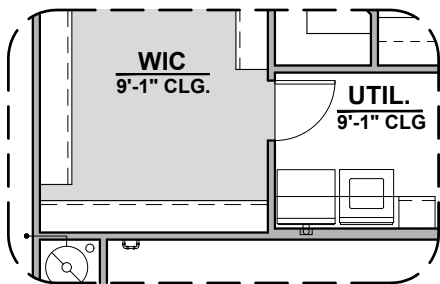

Laundry Door

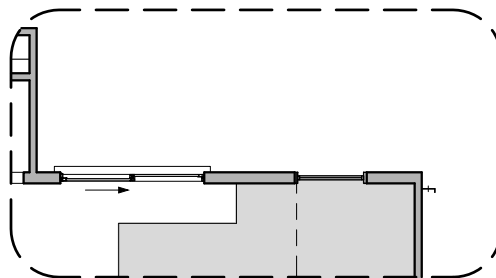

Sliding Glass Door
ILO STD. Door

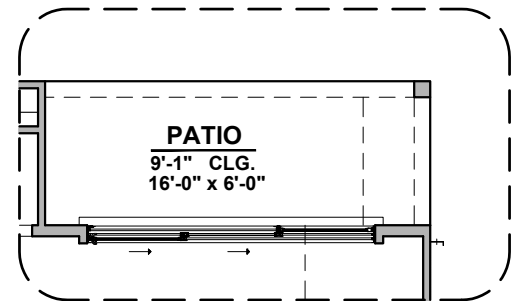

Stacking Door ILO STD. Door

*Note: All vinyl in Great Room with this option